

SM6003A-1000A0

电机尺寸
DIMENSIONS:
(UNIT=MM)

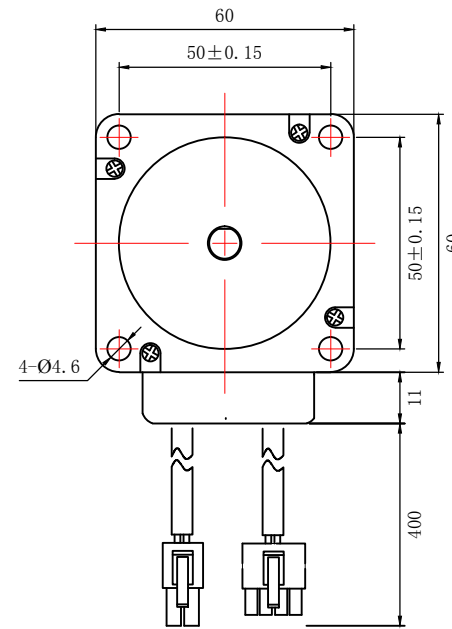
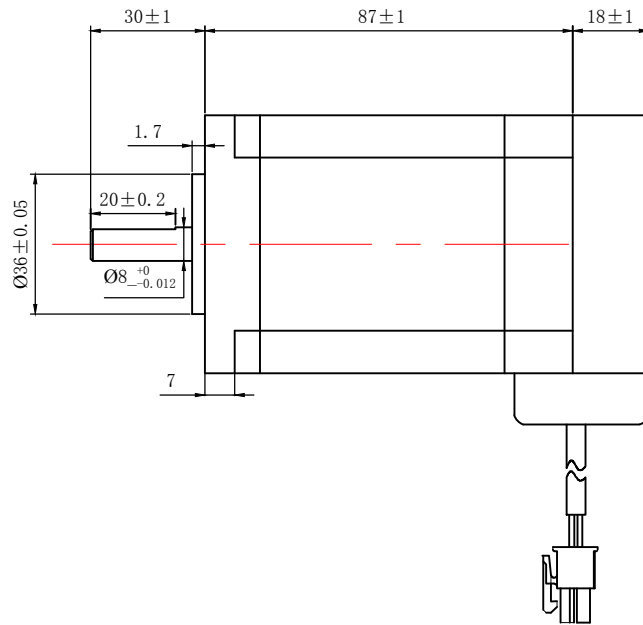

说明
NOTES:

- PLEASE DON'T HOLD MOTOR BY LEAD WIRES.
- PLEASE DON'T PLUG IN/OUT THE MOTOR CONNECTOR WHILE POWER ON.
- PLEASE DON'T DROP, HURL OR DUMP MOTOR AGAINST HARD MATERIAL
MALFUNCTION MAY NOT BE OBSERVED AT EARLY STAGE AFTER SUCH SHOCKS, BUT FOUND LATER. THE MISHANDLING VOIDS OUR WARRANTY.
- DONGGUAN ICAN-TECH WILL NOT BE RESPONSIBLE FOR ANY PATENT DISPUTE OR PROBLEM CAUSED BY ACTUAL APPLICATIONS

驱动连接方式
CONNECTION MODE:

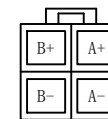

A+	A-	B+	B-
红	白	黑	黄

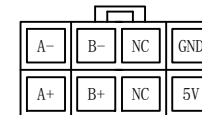

A+	A-	B+	B-	5V	GND
黄	黄白	蓝	蓝黑	红	黑

电机参数/ELECTRICAL PARAMETER		轴径配置/SHAFT DESIGN
电机型号 MANUFACTURER MODEL	SM6003A-1000A0	
适配步进电机驱动器 MATCHED MOTOR DRIVE	SS57	
步距角 STEP ANGLE (° /STEP)	1.8	
电机电压 RATED VOLTAGE (V)	3.2	
电机电流 RATED CURRENT (A/PHASE)	4.0	
电机电阻 RESISTANCE (Ω±15%/PHASE)	0.8	
电机电感 INDUCTANCE (mH±20%/PHASE)	1.5	
电机力矩 HOLDING TORQUE (N.M)	2.4	
编码器分辨率 ENCODER RES	1000	

制图 DESIGNED	检图 CHECKED	校准 APPROVED	日期 DATE	比例 SCALE
HUANGTING	MAHUALING		2016/03/01	1:1.8
SM6003A-1000A0		东莞市一能机电技术有限公司 DONGGUAN ICAN TECHNOLOGY CO., LTD		
闭环步进电机 STEPPER SERVO MOTOR				版本 EDITION V2.0